

# EXPRESS



# La nostra mission è realizzare porte eccellenti che entreranno a far parte delle case arredate col migliore stile e gusto.

*Our mission is to make excellent doors that will feature in the most tastefully and stylishly decorated houses.*

I nostri clienti sono tutti importanti e dedichiamo tutto il nostro impegno, ogni giorno, per dar loro un prodotto dalla qualità superiore con costi accessibili. Prestiamo la massima attenzione alle aspettative dei nostri clienti, che sognano, progettano ed immaginano la loro casa, in cui investono tempo e risorse. È per noi motivo di grande orgoglio far parte di quei sogni.

Il nostro cliente è colui che ci consente ogni giorno di creare nuovi posti di lavoro, innovare ed investire ogni nostra risorsa per migliorare e far crescere il nostro brand nel mondo.

Le porte per noi, non sono semplici oggetti, ma creazioni di abiti sartoriali "su misura" che dovranno calzare nella casa dei nostri clienti rasentando il limite della perfezione.

Ci pregiamo del marchio Made in Italy e lo siamo in ogni componente, nella materia prima, nel design e nella produzione: tutto il nostro prodotto è creato e realizzato in Italia.

Le originali Bertolotto. È la sintesi del nostro modo di lavorare e del nostro successo.

Tutto questo grazie alla fiducia dei nostri clienti, oltre 1,5 milioni di famiglie sparse in oltre 40 paesi del mondo.

*All our customers are very important people and our daily energies are all focused on providing them with a superior quality product at an affordable price. We pay the utmost attention to our customers' expectations: they dream, plan and imagine their homes where they invest their time and resources. We are very proud to be a part of those dreams. For us a client is a person who allows us to create new jobs, innovate and invest all our resources on a daily basis so that we can improve our brand and spread it throughout the world. For us doors are not just objects, they are rather "made-to-measure" one-off creations that will perfectly fit our customers' houses and will reach out almost the perfection. We are honored to have a Made in Italy brand that concerns all the components, from raw materials to design and manufacturing: our product is entirely designed and manufactured in Italy. Original Bertolotto doors are the synthesis of the way we work and why we are successful. All of this thanks to the fact that customers trust us and they are more than 1.5 million households located in over 40 countries throughout the world.*

Ceo  
Bertolotto SpA  
Claudio Bertolotto

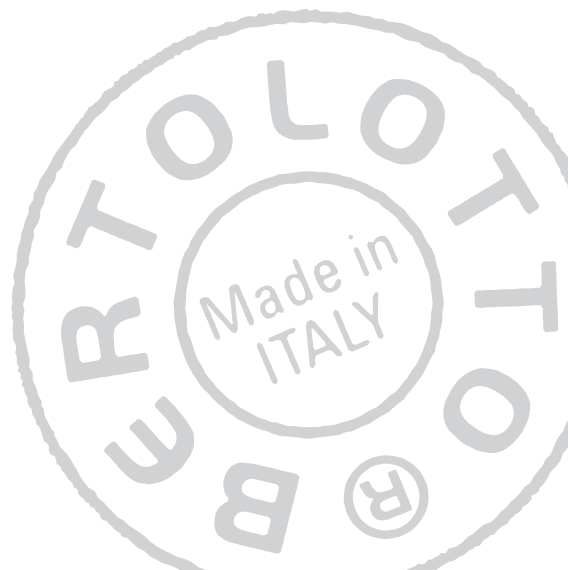





# Le migliori materie prime,

la sapienza dei nostri artigiani e l'utilizzo delle **tecnologie più avanzate** sono il connubio perfetto per produrre **porte per interni, porte blindate e porte tagliafuoco** dal design esclusivo e di alta qualità.

**Porte in legno massello o in materiali high tech, incise, dipinte a mano, classiche** ispirate alla tradizione italiana o minimaliste, moderne e di tendenza.

**Diciannove collezioni, ottanta colorazioni, diciannove essenze** e migliaia di varianti per soddisfare qualsiasi desiderio dei nostri clienti.

# Indice

## 6

VENEZIA

PANT.

06 - Mod. LP8  
PANTOMINIMA



## 8

SYDNEY

08 - Mod. GRAFITE  
10 - Mod. MATERIK  
12 - Mod. 111  
14 - Mod. 134  
16 - Mod. 136  
18 - Mod. 101  
20 - Mod. 102  
22 - Mod. 200  
201  
202

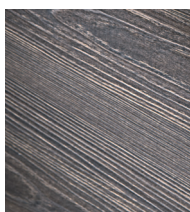

## 24

FASHION

24 - Mod. CL  
ECOPACO



## 26

PETRA

26 - Caratteristiche  
SECUR



## 28

WALDOOR

28 - Mod. CL  
CON PRIMER



# 32

## ACCESSORI

32 - ACCESSORI

34 - SICUREZZA  
E STILE

36 - FINITURE

**EXPRESS**<sup>®</sup>  
by BERTOLOTTO

## LEGENDA

- C COLORAZIONI
- T TELAIO E COPRIFILO
- M MANIGLIA
- P PANNELLO
- V VETRO

## 11.1 TIPOLOGIE DI PORTE PRONTE IN 5 GIORNI!

In 5 giorni tutte le porte Express sono disponibili presso la nostra sede, per il ritiro diretto o tramite corriere.

Ordina le tue porte in poche semplici mosse:

-  scegli i modelli
-  scegli la finitura
-  scegli il sistema di apertura
-  scegli gli accessori
-  compila il modulo d'ordine
-  invia il modulo d'ordine

Entro 24h riceverai la conferma d'ordine via email o fax.  
Ti basterà firmarla e inviarla nuovamente via fax al Nr. **+39.0172.173.0.174** o  
all'indirizzo email **express@bertolotto.com**

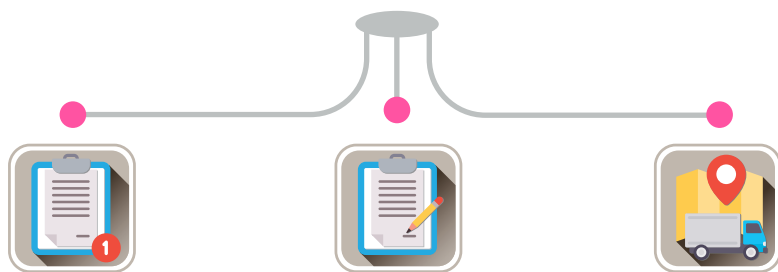

**Ricezione**  
dell'ordine e  
invio della conferma  
d'ordine entro 24h.

Restituzione della  
**conferma**  
d'ordine **firmata** entro  
24h e **start** alla  
produzione.

**Consegna**  
in 6 o 10  
giorni lavorativi.



Express è un servizio a pagamento.

SERVIZIO GARANTITO,  
SODDISFATTI O RIMBORSATI

TUTTA ITALIA E MONDO prodotto pronto franco fabbrica  
in 5 giorni lavorativi.

**ZONA 1** Per le regioni: Piemonte, Liguria, Valle d'Aosta, Lombardia, Emilia Romagna, Umbria, Lazio, Toscana, Campania (fino a Salerno), Veneto (province: Verona, Vicenza, Padova, Rovigo, Venezia) consegna al cliente in 6 giorni lavorativi.

**ZONA 2** Per tutte le altre zone d'Italia consegna al cliente in 10 giorni lavorativi.



● ZONA 1 a casa tua in 6 giorni.

○ ZONA 2 a casa tua in 10 giorni.

N.B. 10 GIORNI LAVORATIVI "PER GLI ORDINI PERVENUTI ENTRO IL GIOVEDÌ".

TEMPI DI CONSEGNA

## Aperture e finiture disponibili



- A** Battente
- C** LACCATO BIANCO
- T** TR/L8
- M** Bilbao cromo sat.
- P** Pantominima



- A** Scorr. a scomparsa
- C** LACCATO BIANCO
- T** TR/L8
- M** Tonda cromo sat.
- P** Pantominima



**TINTA**

LACCATO BIANCO

**APERTURA**

SCORREVOLE A SCOMPARSA

**UNGHIATA**

TONDA CROMO SAT.



Dimensioni disponibili 600/700/750/800/900 x 2100 mm



BATTENTE



Telaio TR/L8  
da 85/105/125/145 mm



SCORREVOLE  
A SCOMPARSA



Kit scorrevole a scomparsa  
TR/L8 da 105 mm



Allargamento  
fascia da 230 mm



DI SERIE  
Serr. mediana e anuba

A RICHIESTA  
- serr. magnetica e anuba  
- serr. magnetica e  
cerniera scomparsa

MODELLO LP8 PANTOMINIMA

# Aperture e finiture disponibili



- A** Battente
- C** GHIACCIO
- T** TL/68
- M** Bilbao cromo sat.
- P** Venatura orizz.



- A** Battente
- C** GRANO
- T** TL/68
- M** Bilbao cromo sat.
- P** Venatura orizz.



- A** Battente
- C** GHIANDA
- T** TL/68
- M** Bilbao cromo sat.
- P** Venatura orizz.



- A** Scorr. a scomparsa
- C** GHIACCIO
- T** TL/68
- M** Tonda cromo sat.
- P** Venatura orizz.



- A** Scorr. a scomparsa
- C** GRANO
- T** TL/68
- M** Tonda cromo sat.
- P** Venatura orizz.



- A** Scorr. a scomparsa
- C** GHIANDA
- T** TL/68
- M** Tonda cromo sat.
- P** Venatura orizz.



- A** PETRA - Secur
- C** GHIACCIO
- T** Testa di moro



- A** PETRA - Secur
- C** GRANO
- T** Testa di moro



- A** PETRA - Secur
- C** GHIANDA
- T** Testa di moro



**TINTA**  
GRANO  
**APERTURA**  
BATTENTE  
**MANIGLIA**  
BIBLO CROMO SAT.



**Dimensioni disponibili 600/700/750/800/900 x 2100 mm**



BATTENTE



Telaio TL/68  
da 75/100 mm



DI SERIE  
Serr. magnetica e  
cerniera a scomparsa



SCORREVOLE  
A SCOMPARSA



Kit scorrevole a scomparsa  
TL/68 da 105 mm



Allargamento  
fascia da 230 mm

**Dimensioni disponibili porta blindata 800/850/900 x 2100 mm**  
spinta SX e DX con falso telaio



BLINDATA

Tutti i rivestimenti forniti sfusi sono di spessore 7 mm, misura 2125 x 970 mm

# Aperture e finiture disponibili



- A** Battente
- C** ANICE
- T** TSUB/LSUB69
- M** Bilbao cromo sat.
- P** Venatura orizz.



- A** Battente
- C** NOCCIOLA
- T** TSUB/LSUB69
- M** Bilbao cromo sat.
- P** Venatura orizz.



- A** Battente
- C** BRUNO
- T** TSUB/LSUB69
- M** Bilbao cromo sat.
- P** Venatura orizz.



- A** Battente
- C** BIANCO
- T** TSUB/LSUB69
- M** Bilbao cromo sat.
- P** Venatura orizz.



- A** Battente
- C** VANIGLIA
- T** TSUB/LSUB69
- M** Bilbao cromo sat.
- P** Venatura orizz.



- A** Scorr. a scomparsa
- C** ANICE
- T** TSUB/LSUB69
- M** Tonda cromo sat.
- P** Venatura orizz.



- A** Scorr. a scomparsa
- C** NOCCIOLA
- T** TSUB/LSUB69
- M** Tonda cromo sat.
- P** Venatura orizz.



- A** Scorr. a scomparsa
- C** BRUNO
- T** TSUB/LSUB69
- M** Tonda cromo sat.
- P** Venatura orizz.



- A** Scorr. a scomparsa
- C** BIANCO
- T** TSUB/LSUB69
- M** Tonda cromo sat.
- P** Venatura orizz.



- A** Scorr. a scomparsa
- C** VANIGLIA
- T** TSUB/LSUB69
- M** Tonda cromo sat.
- P** Venatura orizz.



- A** PETRA - Secur
- C** ANICE
- T** Testa di moro



- A** PETRA - Secur
- C** NOCCIOLA
- T** Testa di moro

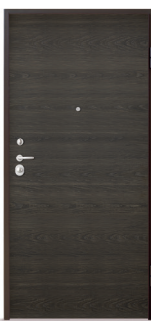

- A** PETRA - Secur
- C** BRUNO
- T** Testa di moro



- A** PETRA - Secur
- C** BIANCO
- T** Testa di moro



- A** PETRA - Secur
- C** VANIGLIA
- T** Testa di moro

**TINTA**  
**NOCCIOLA**  
**APERTURA**  
**BATTENTE**  
**MANIGLIA**  
**BIBLO CROMO SATINATO**



**Dimensioni disponibili 600/700/750/800/900 x 2100 mm**



**BATTENTE**



Telaio TSUB/LSUB69  
da 75 a 125 mm



A RICHIESTA:  
KIT SOR



DI SERIE:  
- serr. magnetica e  
cerniera a scomparsa



**SCORREVOLE  
A SCOMPARSA**



Kit scorrevole a scomparsa  
TSUB/LSUB69 da 105 mm



Allargamento  
fascia da 230 mm

**Dimensioni disponibili porta blindata 800/850/900 x 2100 mm**  
 spinta SX e DX con falso telaio



**BLINDATA**

Tutti i rivestimenti forniti sfusi sono di spessore 7 mm, misura 2125 x 970 mm



# Aperture e finiture disponibili



- A Battente
- C BLANK
- T TD/L8
- M Bilbao cromo sat.
- P Venatura orizz.



- A Battente
- C GESSO
- T TD/L8
- M Bilbao cromo sat.
- P Venatura orizz.



- A Battente
- C LARICE
- T TD/L8
- M Torsion cromo sat.
- P Venatura orizz.



- A Battente
- C ROVERE
- T TD/L8
- M Bilbao cromo sat.
- P Venatura orizz.



- A Scorr. a scomparsa
- C BLANK
- T TD/L8
- M Tonda cromo sat.
- P Venatura orizz.



- A Scorr. a scomparsa
- C GESSO
- T TD/L8
- M Tonda cromo sat.
- P Venatura orizz.



- A Scorr. a scomparsa
- C LARICE
- T TD/L8
- M Tonda ottone luc.
- P Venatura orizz.



- A Scorr. a scomparsa
- C ROVERE
- T TD/L8
- M Tonda cromo sat.
- P Venatura orizz.



- A PETRA - Secur
- C BLANK
- T Testa di moro



- A PETRA - Secur
- C GESSO
- T Testa di moro



- A PETRA - Secur
- C LARICE
- T Testa di moro



- A PETRA - Secur
- C ROVERE
- T Testa di moro

**TINTA**  
**GESSO**  
**APERTURA**  
 SCORREVOLE A SCOMPARSA  
**MANIGLIA**  
 TONDA CROMO SAT.



**Dimensioni disponibili 600/700/750/800/900 x 2100 mm**



**BATTENTE**



Telaio TD/L8  
 da 75/100/120 mm  
 (fino ad esaurimento scorte)



Telaio TL/68  
 da 75/100 mm



DI SERIE  
 Serr. mediana e anuba



**SCORREVOLE  
 A SCOMPARSA**



Kit scorrevole a scomparsa  
 TD/L8 da 105 mm



Allargamento  
 fascia da 230 mm

A RICHIESTA  
 - serr. magnetica e anuba

**Dimensioni disponibili porta blindata 800/850/900 x 2100 mm**  
 spinta SX e DX con falso telaio



**BLINDATA**

Tutti i rivestimenti forniti sfusi sono di spessore 7 mm, misura 2125 x 970 mm

## Aperture e finiture disponibili



- A Battente
- C BLANK
- T TD/L8
- M Soffio cromo sat.
- V Satinato bianco



- A Battente
- C GESSO
- T TD/L8
- M Torsion cromo sat.
- V Satinato bianco



- A Battente
- C LARICE
- T TD/L8
- M Biblo cromo sat.
- V Satinato bianco



- A Battente
- C ROVERE
- T TD/L8
- M Bilbao cromo sat.
- V Satinato bianco



- A Scorr. a scomparsa
- C BLANK
- T TD/L8
- M Tonda cromo sat.
- V Satinato bianco



- A Scorr. a scomparsa
- C GESSO
- T TD/L8
- M Kuader cromo sat.
- V Satinato bianco



- A Scorr. a scomparsa
- C LARICE
- T TD/L8
- M Kuader cromo sat.
- V Satinato bianco



- A Scorr. a scomparsa
- C ROVERE
- T TD/L8
- M Kuader cromo sat.
- V Satinato bianco

**FINITURA**  
 GESSO  
**TELAIO**  
 TD/L8  
**MANIGLIA**  
 TORSION CROMO SAT.



**Dimensioni disponibili 600/700/750/800/900 x 2100 mm**



**BATTENTE**



Telaio TD/L8  
 da 75/100/120 mm  
 (fino ad esaurimento scorte)



Telaio TL/68  
 da 75/100 mm



DI SERIE  
 Serr. mediana e anuba  
 A RICHIESTA  
 - serr. magnetica e anuba



**SCORREVOLE  
 A SCOMPARSA**



Kit scorrevole a scomparsa  
 TD/L8 da 105 mm



Allargamento  
 fascia da 230 mm



DI SERIE  
 vetri di sicurezza temperati  
 Satinato Bianco

**MODELLO 134**



# Aperture e finiture disponibili



- A** Battente
- C** BLANK
- T** TD/L8
- M** Bilbao cromo sat.
- V** Satinato bianco



- A** Battente
- C** GESSO
- T** TD/L8
- M** Torsion cromo sat.
- V** Satinato bianco



- A** Battente
- C** LARICE
- T** TD/L8
- M** Biblo cromo sat.
- V** Satinato bianco



- A** Battente
- C** ROVERE
- T** TD/L8
- M** Bilbao cromo sat.
- V** Satinato bianco



- A** Scorr. a scomparsa
- C** BLANK
- T** TD/L8
- M** Kuader cromo sat.
- V** Satinato bianco



- A** Scorr. a scomparsa
- C** GESSO
- T** TD/L8
- M** Kuader cromo sat.
- V** Satinato bianco



- A** Scorr. a scomparsa
- C** LARICE
- T** TD/L8
- M** Kuader cromo sat.
- V** Satinato bianco



- A** Scorr. a scomparsa
- C** ROVERE
- T** TD/L8
- M** Kuader cromo sat.
- V** Satinato bianco



**FINITURA**

ROVERE

**TELAIO**

TD/L8

**MANIGLIA**

BIBLO CROMO SAT.



**Dimensioni disponibili 600/700/750/800/900 x 2100 mm**



**BATTENTE**



Telaio TD/L8  
da 75/100/120 mm  
(fino ad esaurimento scorte)



Telaio TL/68  
da 75/100 mm



DI SERIE  
Serr. mediana e anuba



**SCORREVOLE  
A SCOMPARSA**



Kit scorrevole a scomparsa  
TD/L8 da 105 mm



Allargamento  
fascia da 230 mm



DI SERIE  
vetri di sicurezza temperati  
Satinato Bianco

# Aperture e finiture disponibili



101 P

- A** Battente
- C** BLANK
- T** TD/L8
- M** Bilbao cromo sat.
- P** Liscio



101 P

- A** Battente
- C** GESSO
- T** TD/L8
- M** Torsion cromo sat.
- P** Liscio



101 V

- A** Battente
- C** LARICE
- T** TD/L8
- M** Biblo cromo sat.
- V** Bianco latte



101 V

- A** Battente
- C** ROVERE
- T** TD/L8
- M** Torsion cromo sat.
- V** Bianco latte



101 V

- A** Scorr. a scomparsa
- C** BLANK
- T** TD/L8
- M** Kuader cromo sat.
- V** Bianco latte



101 V

- A** Scorr. a scomparsa
- C** GESSO
- T** TD/L8
- M** Kuader cromo sat.
- V** Bianco latte



101 P

- A** Scorr. a scomparsa
- C** LARICE
- T** TD/L8
- M** Kuader cromo sat.
- P** Liscio



101 P

- A** Scorr. a scomparsa
- C** ROVERE
- T** TD/L8
- M** Kuader cromo sat.
- P** Liscio

**FINITURA**

LARICE

**TELAIO**

TD/L8

**MANIGLIA**

BIBLO CROMO SAT.



**Dimensioni disponibili 600/700/750/800/900 x 2100 mm**



**BATTENTE**



Telaio TD/L8  
da 75/100/120 mm  
(fino ad esaurimento scorte)



Telaio TL/68  
da 75/100 mm



DI SERIE  
Serr. mediana e anuba  
  
A RICHIESTA  
- serr. magnetica e anuba



**SCORREVOLE  
A SCOMPARSA**



Kit scorrevole a scomparsa  
TD/L8 da 105 mm



Allargamento  
fascia da 230 mm



DI SERIE  
vetri di sicurezza temperati  
Bianco latte



# Aperture e finiture disponibili



102 P

- A** Battente
- C** BLANK
- T** TD/L8
- M** Torsion ottone lucido
- P** Liscio



102 P

- A** Battente
- C** GESSO
- T** TD/L8
- M** Torsion cromo sat.
- P** Liscio



102 P

- A** Battente
- C** LARICE
- T** TD/L8
- M** Tech cromo sat.
- P** Liscio



102 V

- A** Battente
- C** ROVERE
- T** TD/L8
- M** Bilbao cromo sat.
- V** Bianco latte



102 V

- A** Scorr. a scomparsa
- C** BLANK
- T** TD/L8
- M** Kuader cromo sat.
- V** Bianco latte



102 V

- A** Scorr. a scomparsa
- C** GESSO
- T** TD/L8
- M** Kuader cromo sat.
- V** Bianco latte



102 P

- A** Scorr. a scomparsa
- C** LARICE
- T** TD/L8
- M** Tonda cromo sat.
- P** Liscio



102 P

- A** Scorr. a scomparsa
- C** ROVERE
- T** TD/L8
- M** Kuader cromo sat.
- P** Liscio

**FINITURA**

BLANK

**TELAIO**

TD/L8

**MANIGLIA**

TORSION CROMO SAT.



**Dimensioni disponibili 600/700/750/800/900 x 2100 mm**



**BATTENTE**



Telaio TD/L8  
da 75/100/120 mm  
(fino ad esaurimento scorte)



Telaio TL/68  
da 75/100 mm



DI SERIE  
Serr. mediana e anuba  
  
A RICHIESTA  
- serr. magnetica e anuba



**SCORREVOLE  
A SCOMPARSA**



Kit scorrevole a scomparsa  
TD/L8 da 105 mm



Allargamento  
fascia da 230 mm



DI SERIE  
vetri di sicurezza temperati  
Bianco latte

**MODELLO 102**

# Aperture e finiture disponibili



200

- A** Battente
- C** BIANCO
- T** TP/L7
- M** Bilbao cromo sat.
- P** Liscio



200

- A** Scorr. a scomparsa
- C** BIANCO
- T** TP/L7
- M** Tonda cromo sat.
- P** Liscio



200

- A** Battente
- C** NOCE NAZIONALE
- T** TP/L7
- M** Soffio ottone lucido
- P** Venatura verticale



200

- A** Scorr. a scomparsa
- C** NOCE NAZIONALE
- T** TP/L7
- M** Kuader cromo sat.
- P** Venatura verticale



201P

- A** Battente
- C** BIANCO
- T** TP/L7
- M** Futura cromo sat.
- P** Liscio



202P

- A** Battente
- C** BIANCO
- T** TP/L7
- M** Torsion cromo sat.
- P** Liscio



201V

- A** Battente
- C** NOCE NAZIONALE
- T** TP/L7
- M** Bilbao cromo sat.
- V** Bianco latte



202V

- A** Scorr. a scomparsa
- C** NOCE NAZIONALE
- T** TP/L7
- M** Tonda cromo sat.
- V** Bianco latte



- A** PETRA - Secur
- C** BIANCO
- T** Testa di moro



- A** PETRA - Secur
- C** NOCE NAZIONALE
- T** Testa di moro

**FINITURA**  
 BIANCO  
**TELAIO**  
 TP/L7  
**MANIGLIA**  
 FUTURA CROMO SAT.



**Dimensioni disponibili 600/700/750/800/900 x 2100 mm**



**BATTENTE**



Telaio TP/L7  
 da 70/100 mm



**DI SERIE**  
 Serr. mediana e anuba

**A RICHIESTA**  
 - serr. magnetica e anuba



**SCORREVOLE  
 A SCOMPARSA**



Kit scorrevole a scomparsa  
 TP/L7 da 105 mm



Allargamento  
 fascia da 230 mm



**DI SERIE**  
 vetri di sicurezza  
 temperati  
 Bianco latte

**Dimensioni disponibili porta blindata 800/850/900 x 2100 mm**  
 spinta SX e DX con falso telaio



**BLINDATA**

Tutti i rivestimenti forniti sfusi sono di spessore 7 mm, misura 2125 x 970 mm

# Aperture e finiture disponibili



CL ECOPACO

- A** Battente
- C** BIANCO
- T** TR/L8
- M** Linea cromo sat.
- P** Liscio



CL ECOPACO

- A** Scorr. a scomparsa
- C** BIANCO
- T** TR/L8
- M** Kuader cromo sat.
- P** Liscio



- A** PETRA - Secur
- C** BIANCO
- T** Testa di moro



**FINITURA**  
LACCATO ECOPACO BIANCO  
**TELAIO**  
TR/L8  
**MANIGLIA**  
LINEA CROMO SAT.



**Dimensioni disponibili 600/700/750/800/900 x 2100 mm**



**BATTENTE**



Telaio TR/L8  
da 85/105/125/145 mm



DI SERIE  
Serr. mediana e anuba



**SCORREVOLE  
A SCOMPARSA**



Kit scorrevole a scomparsa  
TR/L8 da 105 mm



Allargamento  
fascia da 230 mm

A RICHIESTA  
- serr. magnetica e anuba  
- serr. magnetica e  
cerniera scomparsa

**Dimensioni disponibili porta blindata 800/850/900 x 2100 mm**  
spinta SX e DX con falso telaio



**BLINDATA**

Tutti i rivestimenti forniti sfusi sono di spessore 7 mm, misura 2125 x 970 mm

**MODELLO CL ECOPACO**

# Caratteristiche tecniche

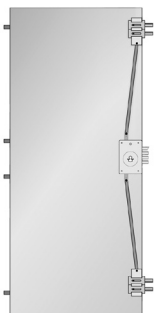

## Equipaggiamento di serie



Elevata resistenza alla corrosione



Chiave con profilo speciale e pomolo interno



Protezione antintrusione CLASSE 3 secondo norma Europea ENV 1627-1



Limitatore di apertura a traslazione (catenella)



Deviatore Block



Istituto certificatore e collaudatore tedesco per la tecnica del serramento di Rosenheim (D)



Serratura movimento ad ingranaggi, a cilindro



Serratura con cilindro europeo



Abbattimento acustico 40dB



Soglia mobile automatica inferiore



4 Rostri di sicurezza posti sul lato cerniera



Trasmittanza termica U=1,8



N°7 Aste telescopiche di chiusura (catenacci)



Spioncino grandangolare

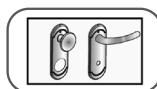

Ferramenta cromo sat. pomolo esterno fisso + maniglia interna

**FINITURA**  
SYDNEY ROVERE  
**TELAIO E CARTER**  
TESTA DI MORO  
**MANIGLIERIA**  
CROMO SATINATO



**Dimensioni disponibili porta blindata 800/850/900 x 2100 mm**  
spinta SX e DX con falso telaio

Tutti i rivestimenti forniti sfusi sono di spessore 7 mm, misura 2125 x 970 mm



Carter e telaio testa di moro

CARATTERISTICHE SECUR

# Porta Walldoor

Il sistema ALL in ONE adatto ad ogni esigenza

Grazie all'esclusivo **sistema Walldoor** potrete facilmente **invertire il senso di apertura** della porta da destra a sinistra, a spingere o a tirare e viceversa grazie ad alcune semplici operazioni.

Walldoor è camaleontico: può infatti essere **verniciato** utilizzando la stessa **pittura** murale delle **pareti**, creando così **aperture coordinate** o diventare elemento di contrasto.

L'effetto delle pitture applicate su un solo lato della porta provoca un effetto di tiratura con conseguente imbarcamento dell'anta. Si consiglia il bilanciamento con la stessa lavorazione eseguita **CONTEMPORANEAMENTE** su entrambe le facce.

Nel **kit** sono presenti sia le **staffe** (per installazione su cartongesso) che le **zanche** (per installazione su muratura). Potete **decidere** direttamente in **cantiere** l'apertura e la **tipologia di installazione**.

**Porta Walldoor lascia spazio alla vostra fantasia!**

## VANTAGGI

- Non occorre specificare l'apertura essendo reversibile
- Non occorre specificare il tipo di parete (muratura o cartongesso)
- Non occorre specificare il tipo di finitura (grezza o cementite)



Battente e telaio pitturabili





**Dimensioni disponibili** 600/700/800/900 x 2100 mm



**FINITURA TELAIO**  
alluminio  
sovraverniciabile



**FINITURA ANTA**  
rivestimento Primer  
sovraverniciabile



**SERRATURA  
MAGNETICA**  
cromo



**COVER CERNIERA ESTERNO**  
per proteggere dallo stucco  
nel montaggio



**CERNIERE**  
a scomparsa regolabili e reversibili (spinta  
dx, spinta sx, tirare a sx, tirare a dx)



**FISSAGGIO**  
per muratura e per  
cartongesso

# Tipologie di installazione disponibili con un unico telaio

## CARTONGESSO

Apertura  
a spingere  
filo esterno  
spinta SX

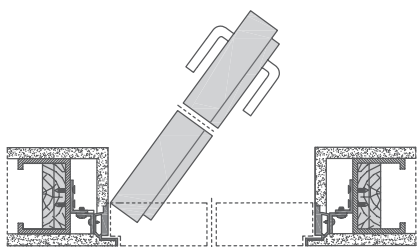

Apertura  
a spingere  
filo esterno  
spinta DX

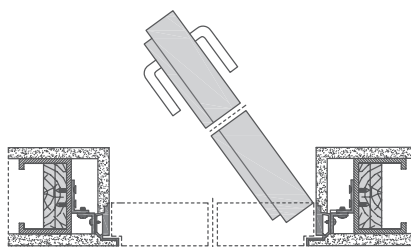

Apertura  
a tirare  
filo esterno  
tira SX

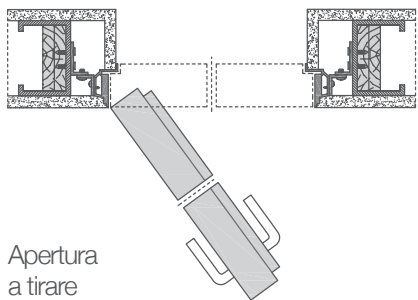

Apertura  
a tirare  
filo esterno  
tira DX

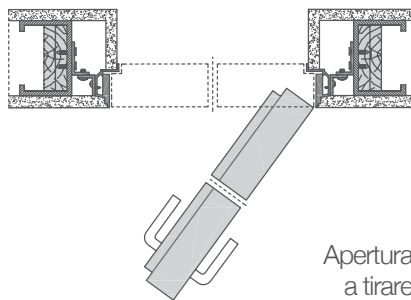

## MURATURA

Apertura  
a spingere  
filo esterno  
spinta SX

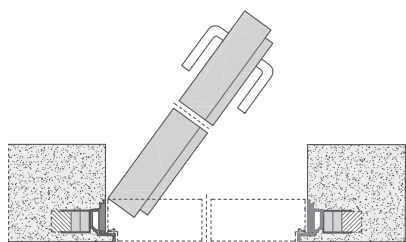

Apertura  
a spingere  
filo esterno  
spinta DX

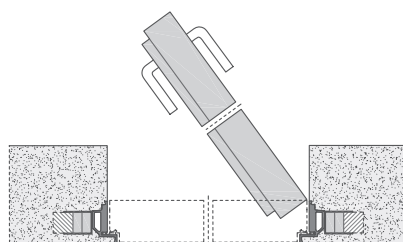

Apertura  
a tirare  
filo esterno  
tira SX

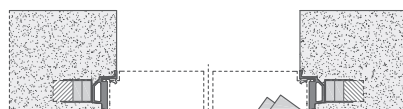

Apertura  
a tirare  
filo esterno  
tira DX

# BATTENTE



BILBAO  
cromo satinato

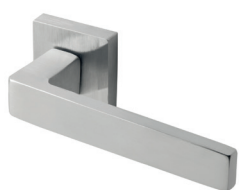

BIBLO  
cromo satinato



BICA  
argento



FEBO  
ottone lucido



FUTURA  
ottone lucido



LINEA  
ottone lucido



SOFFIO  
ottone lucido



TORSION  
ottone lucido



VIRGOLA  
ottone lucido



**MANIGLIE:** FEBO, FUTURA, LINEA, SOFFIO, TORSION, VIRGOLA  
disponibili anche con finitura cromo satinato

# SCORREVOLE



KIT UNGHIATA TONDA  
ottone lucido



KIT UNGHIATA TONDA  
cromo satinato

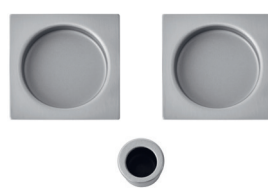

KIT UNGHIATA KUADER  
cromo satinato



KIT L/O TONDA  
ottone lucido



KIT L/O TONDA  
cromo satinato

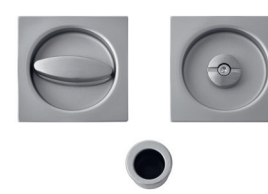

KIT L/O KUADER  
cromo satinato



# Sicurezza e stile

## La cura nei dettagli

Bertolotto Porte cura ogni aspetto del prodotto.

L'imballaggio è progettato e realizzato per proteggere il prodotto da urti o eventuali danni, garantendo l'integrità del contenuto e rendendolo immediatamente riconoscibile.

La qualità Bertolotto è presente anche nei dettagli.



Chiavi



Sigillo moneta nella battuta dell'anta



Porte imballate con telaio preassemblato.

Per modello Grafite: Porte imballate con telaio in scatola



Confezione maniglie

# TIPOLOGIE E COLORI

MODELLO		Blank	Rovere	Larice	Gesso	Noce Nazionale	Bianco	Grano	Ghianda	Ghiaccio	Ecopaco Bianco	Materik Bianco	Materik Vaniglia	Materik Anice	Materik Nocciola	Materik Bruno	Laccato Bianco
MATERIK												•	•	•	•	•	
GRAFITE								•	•	•							
SYDNEY	111	•	•	•	•												
SYDNEY	136	•	•	•	•												
SYDNEY	134	•	•	•	•												
SYDNEY	101P	•	•	•	•												
SYDNEY	101V	•	•	•	•												
SYDNEY	102P	•	•	•	•												
SYDNEY	102V	•	•	•	•												
SYDNEY PRINT	201P					•	•										
SYDNEY PRINT	201V					•	•										
SYDNEY PRINT	202P					•	•										
SYDNEY PRINT	202V					•	•										
SYDNEY PRINT	200					•	•										
FASHION	CL										•						
PANTOMINIMA	LP8																•
SECUR	MATERIK											•	•	•	•	•	
SECUR	GRAFITE							•	•	•							
SECUR	111	•	•	•	•												
SECUR	200					•	•										
SECUR	CL										•						

**EXPRESS**<sup>®</sup>  
by BERTOLOTTO

DAVERO INFINITE LE COMBINAZIONI MODELLO, COLORE, MISURE E TIPOLOGIE.

EXPRESS TI GARANTISCE SEMPRE, UN SERVIZIO AFFIDABILE DE Le Originali Bertolotto<sup>®</sup>

# COLORI

## SYDNEY



Blank



Gesso



Larice



Rovere

## MATERIK



Bianco



Vaniglia



Anice



Nocciola



Bruno

## GRAFITE



Grano



Ghiaccio



Ghianda

## SYDNEY PRINT



Bianco



Noce Nazionale

## LACCATO



Bianco



Ecopaco  
Bianco



Bertolotto al passo con le tempistiche moderne pone sempre attenzione alle necessità dei clienti.  
Anche quelli più esigenti.

EXPRESS

VIII. EDIZIONE Settembre 2017

Bertolotto S.p.A. si riserva il diritto di apportare, senza preavviso, ogni modifica volta al miglioramento funzionale e qualitativo dei prodotti. Le informazioni e i disegni rappresentati in questo catalogo, oltre ad avere carattere puramente illustrativo sono suscettibili di variazioni. I campioni di colori e materiali presentati in questo stampato hanno un valore indicativo compatibilmente con i limiti di riproduzione e stampa.

© PROPRIETA' di Bertolotto S.p.A. - Tutti i diritti riservati - I marchi e gli altri segni distintivi, i testi, le fotografie, i disegni ed i modelli, i prodotti e gli altri materiali riportati nella presente brochure e tutti i diritti di proprietà intellettuale ed industriale ad essi relativi costituiscono proprietà riservata di Bertolotto Porte S.p.A. E' vietata la riproduzione, copia, imitazione, pubblicazione, diffusione, distribuzione, elaborazione e qualsiasi uso, anche parziale, nella pubblicità, sui prodotti, confezioni, materiali illustrativi o pubblicitari, siti internet, nelle attività di marketing e commerciali ed ogni altro uso, senza la preventiva autorizzazione scritta di Bertolotto S.p.A.

Bertolotto S.p.A. reserves the right to change, without notice, any modification to the improvement functional and quality of the products. The information and drawings in this catalog, as well as have purely illustrative are subject to change. Samples of colors and materials presented in this publication are indicative consistent with the limitations of reproduction and printing.

© PROPERTIES of Bertolotto S.p.A. - All rights reserved - Trademarks and other distinctive signs, texts, photographs, drawings and models, products and other materials contained in this brochure and all the intellectual and industrial property rights are copyrighted by Bertolotto Porte S.p.A. It's forbidden their reproduction, copying, imitation, publication, dissemination, distribution, processing and use, even partial, advertising, products, packaging, artworks or advertising, websites, marketing activities and sales and all other use without the prior written permission of Bertolotto S.p.A.

Bertolotto S.p.A.  
Circonvallazione G. Giolitti 43/45  
12030 Torre San Giorgio (CN) Italy  
Tel. +39.0172.91.28 - Fax +39.0172.91.28.00  
[www.bertolotto.com](http://www.bertolotto.com) - [express@bertolotto.com](mailto:express@bertolotto.com)